

ionmax

Ion632 **Desiccant Dehumidifier**

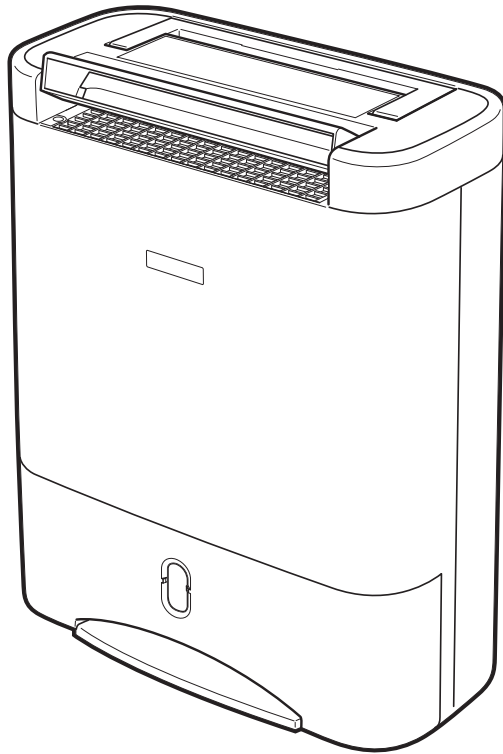

User Manual

INDEX

IMPORTANT SAFETY INSTRUCTIONS	1
FEATURES	2
SPECIFICATIONS.....	2
PRODUCT DESCRIPTION	3
THE CONTROL PANEL	4
UNIT SETUP.....	5
TO OPERATE SAFELY	5
OPERATING INSTRUCTIONS	6-10
EMPTYING THE BUCKET	11
CONTINUOUS DRAINAGE OPTION.....	12
MAINTENANCE	13
TROUBLESHOOTING	14-15
WARRANTY DETAILS	16
WARRANTY REGISTRATION.....	17

Please read the user manual to ensure safe and proper usage.

Please read the instructions carefully before using and keep user manual where it is easily accessible for future reference.

PLEASE NOTE:

The user manual may be altered at any time to assist in quality improvement.
The design and product development may be upgraded without public notice.

IMPORTANT SAFETY INSTRUCTIONS

PLEASE READ ALL INSTRUCTIONS CAREFULLY BEFORE OPERATING.

WARNING - This appliance is intended for use in a domestic environment only. Any other use is not recommended by the manufacturer and may cause fire, electrical shocks or other injury to person or property.

When using electrical appliances, basic safety precautions should always be followed:

1. Do not operate the unit with a damaged cord or plug, after it malfunctions or has been dropped or damaged in any way. Return to an authorised service facility for examination and repair.
2. This unit should always be kept in an upright position to avoid any damage. Locate the unit on a flat stable surface.
3. Check the household voltage to ensure it matches the unit's rated specification before operating.
4. Operate this unit in an ambient temperature between 1°C and 40°C.
5. Ensure that the air inlets and outlets are not blocked or covered.
6. Do not place the unit too close to curtains or other objects - min 40cm.
7. When using the "LAUNDRY MODE" to speed up the drying of wet clothes in the room, please keep the clothing at a safe distance from the unit to prevent water from dropping onto the unit.
8. Never place anything on top of the unit and do not cover with any kind of material while in use.
9. This product is intended for domestic and light office use ONLY and not for commercial, industrial or outdoor use.
10. To protect against electrical shocks, do not immerse unit, plug or cord in water, or spray with liquids.
11. Never unplug the power cord without pressing the "ON/OFF" button to off first, as this could damage the unit.
12. Always unplug the unit when not in use or moving location. To disconnect from the power supply, grip the plug and pull from the power socket. Never pull by the cord.
13. Always empty the water tank before storing the unit away.
14. Close supervision is necessary when any appliance is used by or near children and pets.
15. Do not run power cord under carpeting, or cover with rugs or runners. Arrange the cord away from areas where it may be tripped over.
16. Never operate or store the unit in direct sunlight.
17. To repair the unit, take it to a qualified service engineer. Repairs carried out by unqualified people may cause damage to the unit or injury to persons or property and void the warranty.
18. Where possible, avoid the use of an extension cable as they may overheat and cause a risk of fire. Only use an extension cord after ensuring it is in perfect condition.
19. Do not use the unit without the air filter.

This appliance is not intended for use by persons (including children) with reduced physical, sensory or mental capabilities, or lack of experience and knowledge, unless they have been given supervision or instruction concerning use of the appliance by a person responsible for their safety. Children should be supervised to ensure that they do not play with the appliance.

SAVE AND READ THESE IMPORTANT SAFETY INSTRUCTIONS

FEATURES

- **Compressorless dehumidifier** - uses desiccant rotor technology
- **Environmentally friendly** - with no harmful gases and quiet in operation
- **Automatic swing louvre**
- **Moisture removal** - 10 litres/day (20°C RH60%)
- **Water tank capacity** - 3.5 litres
- **Electronic louvre**
- **Laundry mode** - helps to dry out damp clothes
- **Up to 8 hour timer** - for added convenience
- **Temperature range for use** ~ 1°C - 40°C
- **Light & portable with carry handle**
- **Removable water bucket with handle**
- **Auto restart after power cut**
Once the power is restored after a power failure, the appliance will continue to operate at the selected settings prior to the power failure.
- **Safety function**
Adaptive control, Fall-down, water-full and abnormal temperature detection
- **Silver Nano Technology Filter**
Prevents the growth of bacteria on the filter, improving the quality of air in your home

SPECIFICATIONS

Model: Ionmax Ion632

Voltage: 220-240V ~ 50Hz

Power consumption: 420-740W

Net weight: 7.8kg

Dimensions (W x D x H): 416mm x 186mm x 520mm

PRODUCT DESCRIPTION

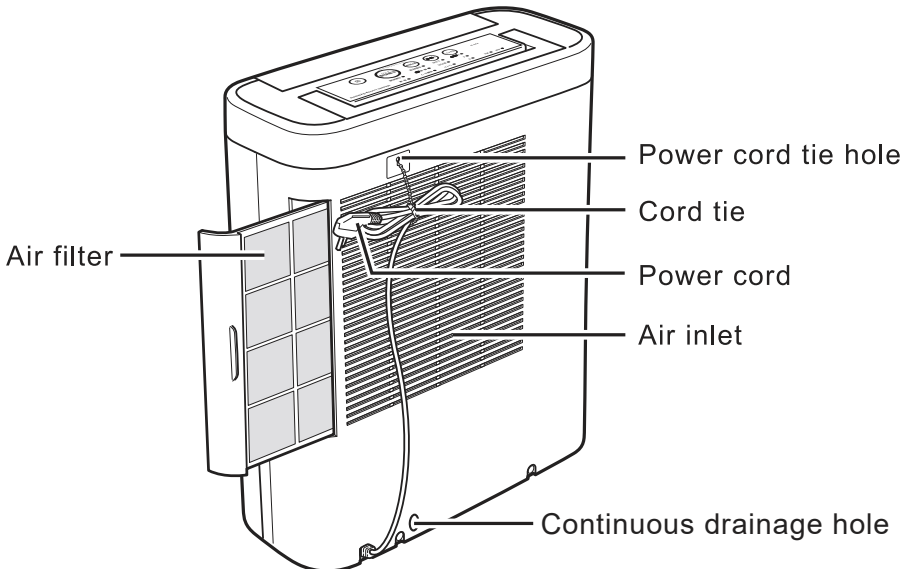
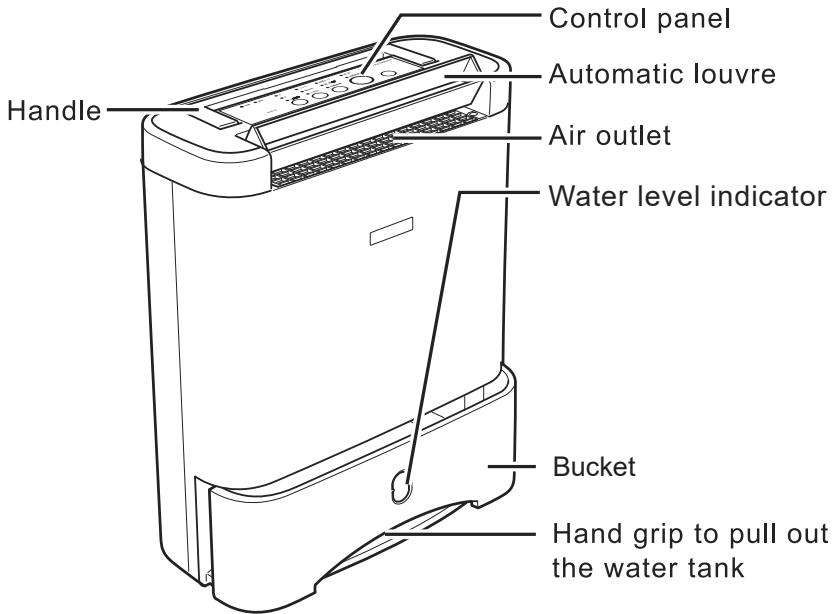

THE CONTROL PANEL

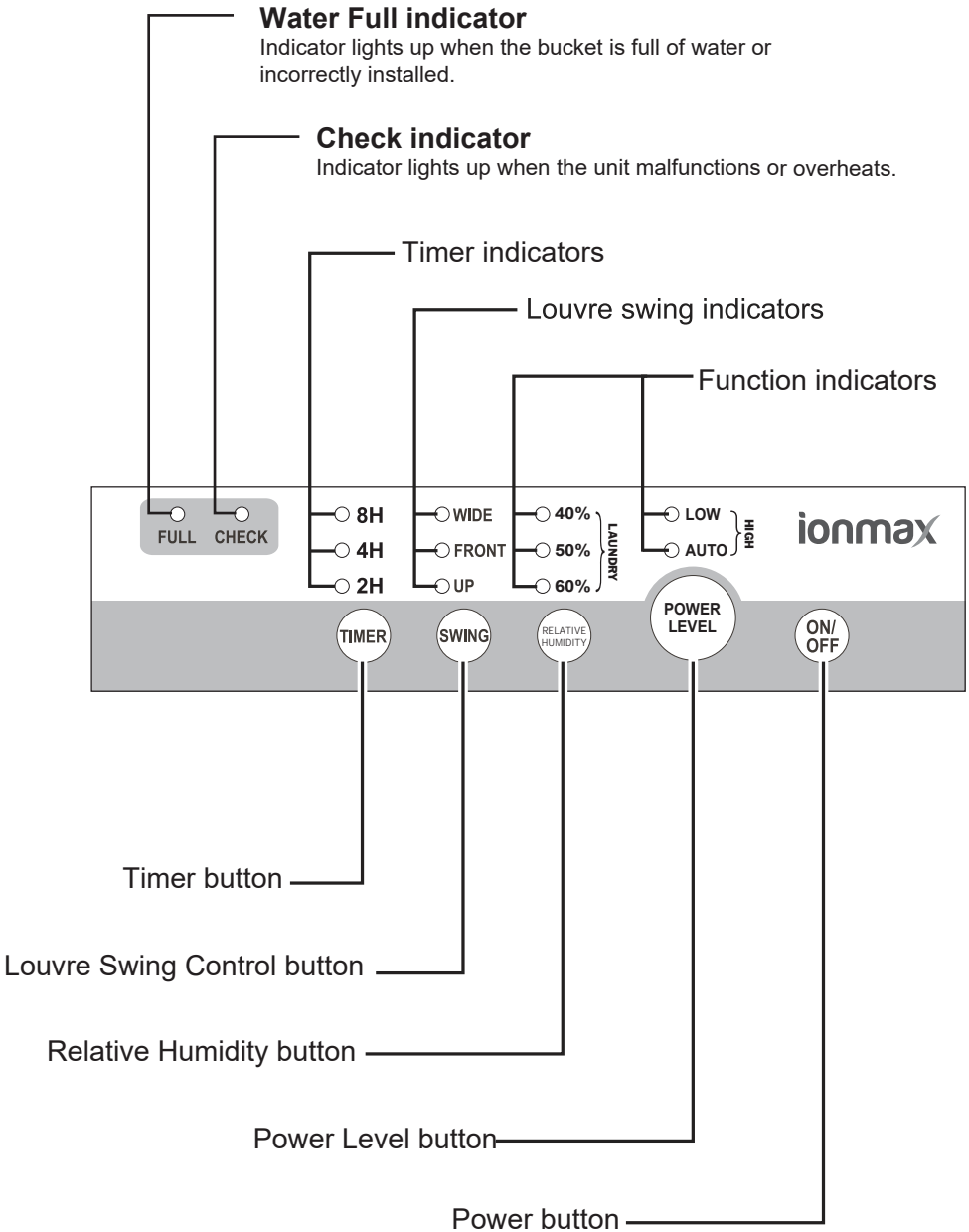

UNIT SETUP

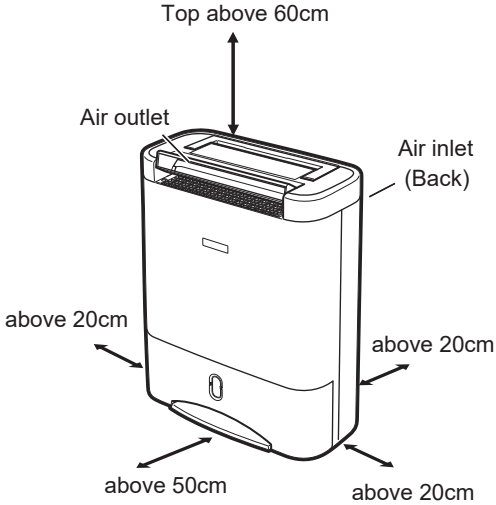

- Place the unit in an upright position on a stable, level surface. (Please ensure unit is not sitting on its own cable)
- Please ensure the unit is a safe distance away from walls and furniture (see image on the left).
- Please keep clothes at a safe distance of 60cm from air outlet of the unit to prevent water dripping into the unit.
- For best results, position the dehumidifier somewhere central like a landing or a hallway. As long as the internal doors are open, the excess moisture from all of the rooms in the house will migrate naturally towards the dehumidifier and be processed.



CAUTION: Do not place the dehumidifier in a broom cupboard, boiler room, small unventilated rooms etc. Avoid placing the dehumidifier in small confined areas or in close proximity to a radiator or heat source such as tumble driers and cookers to prevent the dehumidifier from overheating.



Do not use this dehumidifier in dusty or industrial environments where particles can get into the dehumidifier. This will cause a malfunction and void your warranty.

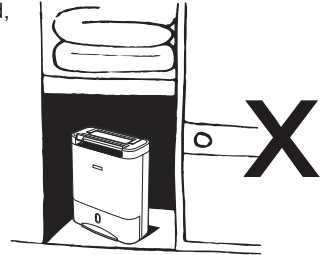

TO OPERATE SAFELY

Do not insert small objects into the unit as this will damage it and cause a hazard.

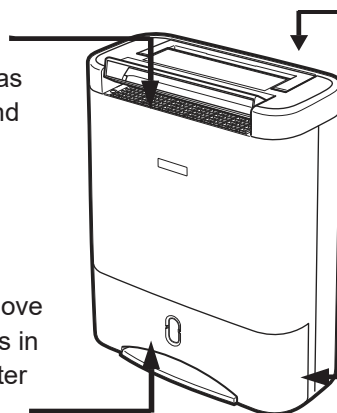

Maintain safe clearance space as shown in Unit Setup above

Do not attempt to remove the bucket while unit is in operation to avoid water leakage.

Ensure bucket is fitted correctly.

OPERATING INSTRUCTIONS

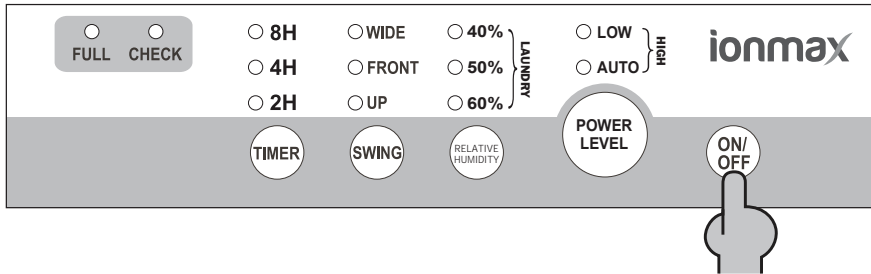

ON and OFF

Connect the power plug to the appropriate electrical socket outlet.
Press the ON/OFF button to turn the appliance ON.
Press the ON/OFF button again to turn the appliance OFF.

Note: In the event of a power failure

Once the power is restored after a power failure, the appliance will continue to operate at the selected settings prior to the power failure.

This includes the power level, relative humidity, swing function and time remaining in timer mode.

Note: After turning the appliance OFF

After turning the appliance OFF using the ON/OFF button, the fan will continue to run for a two minute period. This is a normal procedure and helps to cool and protect the internal components.

During these two minutes, DO NOT remove the power plug from the electrical socket outlet; wait for the fan to stop running.

OPERATING INSTRUCTIONS

RELATIVE HUMIDITY

- Press the "RELATIVE HUMIDITY" button to select your desired humidity level.
- For example, if 50% RH is selected, the heater will operate and dehumidification will occur when the room humidity level is detected at above 50% RH.



MODE	DESCRIPTION
60%	Maintain the room at a comfortable indoor humidity level Note: Use this mode for maximum energy saving and quiet operation.
50%	Inhibit mould and bacteria growth Note: Use this mode for daily normal household use to maintain humidity at a healthy level of 55%RH (Bacteria and mould will not breed at this level).
40%	Super dry mode to prevent condensation Note: Use this to control a very damp room in the first couple of days and then switch to 50% or 60% to save energy.
Laundry (Continuous)	Suitable in winter to dry clothes faster <ul style="list-style-type: none">• The unit automatically provides heated air to dry clothes faster with higher power consumption.• The heater will continue to operate at the set power level regardless of the humidity level, unless the ambient temperature becomes too high. Note: <ul style="list-style-type: none">• In Auto power setting, the heater and fan will run on "High" until the humidity level is above 40% RH. Below 40% RH, the heater and fan will run on "Low".• It can take between 2 – 8 hours to dry your laundry, depending on the power level selected. You may want to put the dehumidifier on the timer when using Laundry mode to avoid wasting energy.• To prevent excess energy consumption, avoid using Laundry mode for normal daily use. You may use for extreme drying of very damp rooms over and then switch to one of the three preset humidity levels.

Note:

- RH indicated has a $\pm 10\%$ RH tolerance and may vary depending on room temperature.
- When the unit is set to 60%, 50% and 40% RH humidity level, the heater and fan will operate at the specified power level until the room humidity level reaches the set humidity setting, unless ambient temperature becomes too high. Once the desired humidity level is reached, the fan will continue operating but the heater will turn off.

OPERATING INSTRUCTIONS

POWER LEVEL

- Press the "POWER LEVEL" button to select the desired power level for the fan and heater





MODE	DESCRIPTION
Auto	Convenient automatic operation <ul style="list-style-type: none">• Fan and Heater settings will be automatically controlled until the specified humidity has been reached.• Once desired humidity has been reached, the fan will continue to run on "Low" but the heater will turn off (except in Laundry mode).
Low (Quiet)	Power saving, low noise and long term operation, suitable for daily use <ul style="list-style-type: none">• Fan and Heater will operate on "Low" until specified humidity has been reached.• Once desired humidity has been reached, the fan will continue to run on "Low" but the heater will turn off.
High	For rapid dehumidification <ul style="list-style-type: none">• Fan and Heater will operate on "High" until specified humidity has been reached.• Once desired humidity has been reached, the fan will continue to run on "High" but the heater will turn off.

OPERATING INSTRUCTIONS

AUTO SWING LOUVRE

- Press the "SWING" button to select air louvre angle.

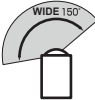

MODE	DESCRIPTION
Up	<ul style="list-style-type: none">• The automatic louvre swings in an upward range of approx 100° 
Front	<ul style="list-style-type: none">• The automatic louvre swings in a front range of approx 50° 
Wide	<ul style="list-style-type: none">• The automatic louvre swing in a wide range of approx 150° 
Hold	<ul style="list-style-type: none">• The automatic louvre stops swinging when you press "SWING" button and turns the LED off.

OPERATING INSTRUCTIONS

TIMER MODE

- Press the "TIMER" button to select your desired running time (2,4 or 8 hours).
The unit will automatically switch off at the end of the selected time period.
As the time counts down , the LED (4 or 2 hours) lights will indicate the time remaining.
- When no "TIMER" is set (the LED is off), the unit will run continuously, or until the drain bucket becomes full.

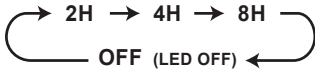

EMPTYING THE BUCKET

1. When the bucket is full, the "FULL" LED illuminates and the unit stops.
2. Do not move the unit or remove the bucket if the machine is still operating as water may leak, damage the unit or cause an electric shock.
3. To remove the bucket, pull it out by gripping the bottom of the bucket and lifting it carefully.
4. Remove the cover of the bucket first, then pour the water away, clean the bucket and restore the cover and the bucket to the correct position.

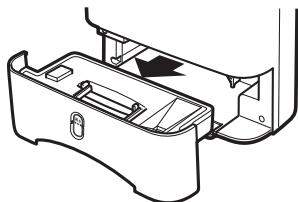

A Pull bucket out

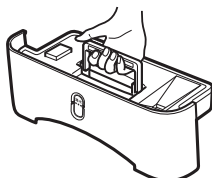

B Lift by the handle

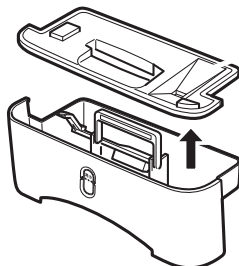

C Remove the cover

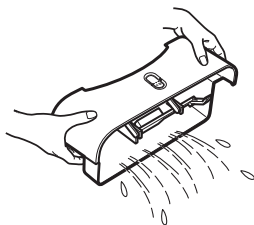

D Pour the water contents

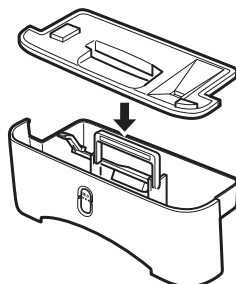

E Refit the cover

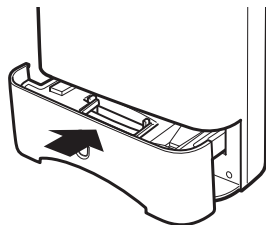

F Install the bucket

NOTE:

- Clean the bucket with clean water if needed. Do not use detergent, solvents, abrasives or hot water to avoid damage to the appliance.
- Do not remove or damage the float in the bucket; the unit will not work correctly.
- The bucket cover must be well fitted in position.
- The "FULL" LED illuminates if the bucket is not positioned correctly.

CONTINUOUS DRAINAGE OPTION

A hose with an inner diameter of 12mm can be connected for continuous drainage.

1. Remove the bucket.
2. There is a through hole at the lower left corner on the back of the appliance.
3. Pass the hose through the hole.
4. Remove the plug from the drain hole at the back of the bucket.
- Keep it safely for future use.**
5. Push and connect the hose firmly to the drain hole of the bucket.
6. Restore the bucket in the correct position.

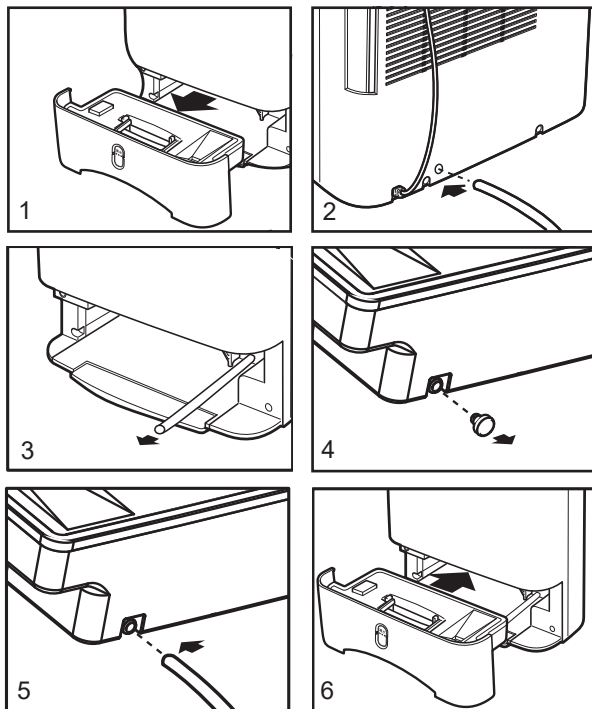

Cleaning the unit

1. Turn off the unit, wait for the fan to stop and unplug from the power socket.
2. Clean the casing using a soft damp cloth with warm water and mild detergent.
Do not use solvents or abrasive materials.
3. Dry thoroughly with a soft dry cloth after cleaning.
4. In order to avoid damage, do not wash the machine with water or let water drip into the air inlet or outlet.

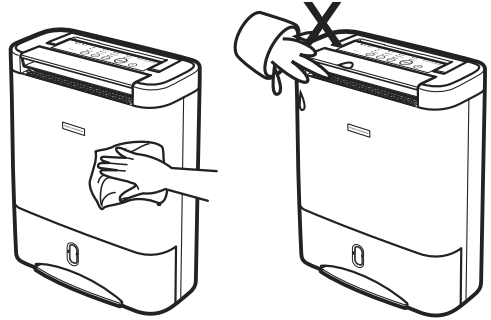

Cleaning the filter

If the filter is covered with dust, the airflow and the performance of the unit will be affected. Check the filter periodically to ensure any dust is removed (It is recommended to check and clean the air filter every 2 weeks or at an appropriate frequency depending on your usage and air environment).

1. Turn the appliance OFF and ensure the plug is removed from the socket outlet.
2. Remove the filter located at the back of the appliance.
3. Clean the filter using a vacuum cleaner.
4. Restore the filter into the appliance.



CAUTION: Never run the unit without the filter. Dust build up in the unit can cause malfunction and overheating.

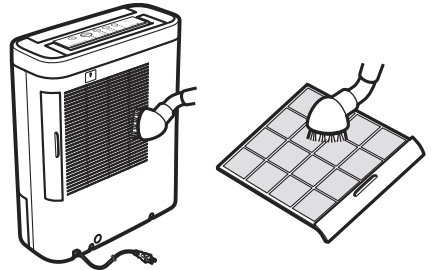

Before storing

1. Turn off the unit, wait for it to stop and unplug from the power socket.
2. Clean and dry the bucket. Leave the unit to drain for approximately one day.
3. Clean the filter and the unit. Cover the unit to prevent it from gathering dust. Store upright in a cool dry place.
4. Do not expose to direct sunlight.

Smell coming from the dehumidifier

When you first use the dehumidifier and periodically afterwards you might notice a smell coming from the dehumidifier. This is caused by the Zeolite desiccant material and is not a sign that the dehumidifier is faulty, nor is it harmful to humans or pets. The smell occurs because the Zeolite absorbs odours from items like cigarettes, cosmetics, hair sprays, building materials and new furniture and then when the desiccant is heated, the smell is discharged into the room. This smell has been described as being like a burning smell or a sour smell. It is normal, will not last long and is not a sign of a fault.

Amount of water collected

When you first use your dehumidifier, it will work harder to reduce the room humidity to its target of e.g. 60% RH humidity setting. This is the time when it will produce the most water and need emptying most frequently. As the room becomes dryer the dehumidifier collects less water and runs at a lower fan speed. This is normal. When the target relative humidity has been reached the air coming out of the dehumidifier will not be heated and it will only be running in low fan mode. This is because there is no need for dehumidification at this point and the dehumidifier is sampling the air to check the current relative humidity to see if dehumidification is required.

If you find that you still have condensation on your windows or you need to dry the air further, then try lowering the desired humidity level to 40%. Avoid using Laundry mode for this purpose. Note that condensation may be more common if you have single glazed windows or if the outside air temperature drops to freezing.

Ventilation

The dehumidifier must not be placed in a confined space. Move the dehumidifier to a well ventilated area for example in a hallway, landing or a ventilated room. Ensure that it is not in close proximity to any form of heat source, such as a radiator or appliances that generate heat (e.g. tumble dryer or cooker). The air inlet and outlet must not be obstructed.

TROUBLESHOOTING

The following conditions are normal:

1. The fan is still running about 2 minutes after turning off the the unit.
2. The unit works within room temperature about 1~40°C. It may stop operation out of this range or when the air inlet or outlet is covered. (The "CHECK" LED light will illuminate)
3. The unit includes heater function that could increase the room temperature.

If your dehumidifier stops working or "CHECK" LED illuminates, please check the following items first.

Problem	Possible Causes	What to Do
Dehumidifier doesn't start (no LEDs on)	The unit is unplugged	Make sure the plug is pushed completely into the outlet.
	The fuse is blown or circuit breaker is tripped	Check the house fuse / circuit breaker box and replace fuse or reset the breaker.
	The unit falls down or is not level on the floor / surface	Place the unit on a stable, level surface.
Very little water is collected	The room humidity has reached the setting	It is normal, you may choose a lower humidity setting (e.g. 40%RH) for drier air.
	The ambient temperature is too high, such as over 40°C	Do not use it in a small and closed place where heat accumulates. Move to a cooler place, wait at least 10 minutes to resume operation.
"FULL" LED on	The bucket is full or not in place	Empty the bucket, check the float in position, and replace the bucket.
"CHECK" LED on	The air inlet or outlet is covered / blocked	Make sure there is nothing blocking the air inlet and air outlet of the unit. Clean the filter. Unplug and wait at least 10 minutes to resume operation.
	Filter clogged with dust	
Leaking	The unit is not level	Check the unit is placed on a level surface and not accidentally sitting on a cable etc.
	The drainage is clogged or loose	Check the drainage hose and its connection.
Unit is noisy	Unit is not on a horizontal flat and level surface.	Move and reset the unit.
	Air filter is dirty.	Clean the filter.

NOTE:

1. If the "CHECK" LED illuminates, turn off the unit, unplug from the power socket, check and clean the filter. If it is dirty, remove any obstacle that covers the air inlet or outlet, and wait for at least ten minutes before plugging in and switching back on.
2. Please contact your retailer if the problem continues. Do not try to repair it yourself, as this could cause an electrical shock and void your warranty.



WARRANTY DETAILS

Congratulations on your purchase! It is our aim to provide you with quality products that you can trust. Our products come with guarantees that cannot be excluded under the Australian Consumer Law. You are entitled to a replacement or a refund for a major failure and for compensation for any other reasonably foreseeable loss or damage.

You are also entitled to have the goods repaired or replaced if the goods fail to be of acceptable quality and the failure does not amount to a major failure.

The Guarantee

The product is guaranteed to be free from defects in workmanship and parts for a period of 12 months from date of purchase for domestic use and 3 months for commercial use. Defects that occur within this warranty period, under normal use and care, will be repaired, replaced or refunded at our discretion, solely at our option with no charge for parts and labour. The benefits conferred by this warranty are in addition to all rights and remedies in respect of the product that the consumer has under the Trade Practices Act and similar state laws.

Proof of Purchase

This warranty is valid for the original purchase and is not transferable. Please keep your purchase docket or receipt as proof of purchase and as proof of date on which the purchase was made. The purchase docket (or a copy) or receipt must be presented with the warranty when making a claim under this warranty.

Service during the Warranty Period

Please ensure that the RA# (Return Authorisation Number) is clearly stated on the outside of the packaging. Don't have one? Call us on 1300 800 200 and we'll get you one. Please ensure the product is properly packaged so as to ensure that no damage occurs to the product during transit.

Extent of Warranty

This warranty is limited to defects in workmanship or parts. All defective products or parts will be repaired or replaced. This warranty does not cover manuals and packaging.

Normal Wear and Tear

This warranty does not cover normal wear and tear to the product or parts.

Exclusions

This warranty does not cover:

- Any defect caused by an accident, misuse, abuse, improper operation, lack of reasonable care, unauthorised modification, loss of parts, tampering or attempted repair by a person not authorised by the distributor.
- Any product that has been damaged by a lightning strike either directly or indirectly or a mains power surge or liquid ingress.
- The product if it is located outside of Australia.
- Any damage caused by improper power input or improper cable connection.

Andatech Pty. Ltd.

PO BOX 3038 Nunawading VIC 3131

Phone: 1300 800 200 Fax: 1300 883 802 Email: support@andatech.com.au

A black square badge with a white border. Inside, the number "1" is written in a large, bold, white font. Below the "1", the words "YEAR" and "WARRANTY" are written in a smaller, white, sans-serif font, stacked vertically.

1
YEAR
WARRANTY

WARRANTY REGISTRATION

Register your Ionmax Ion632 online at my.andatech.com.au

Alternatively, fill out this form and forward to the address below
with a copy of your proof of purchase.

Andatech Pty Ltd
PO Box 3038, Nunawading VIC 3131, Australia.

Product	:	Ionmax Ion632
Date of Purchase	:	_____
Place of Purchase	:	_____
Serial No.	:	_____
Surname	:	_____
Given Name	:	_____
Address	:	_____
Suburb	:	_____
Postcode	:	_____
State	:	_____
Contact No.	:	_____
Email	:	_____



